

PLAN

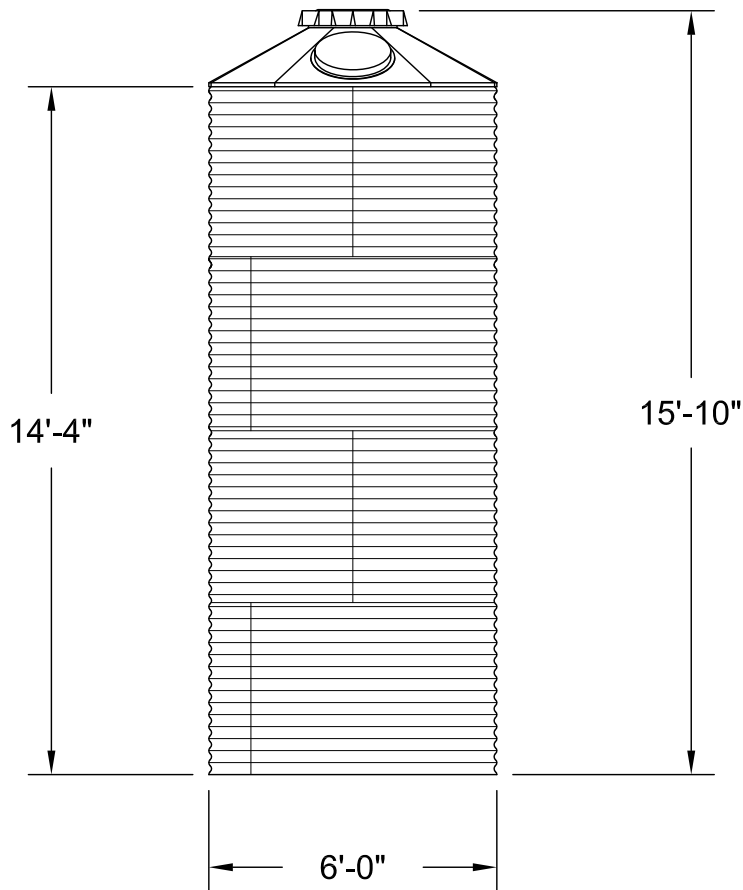

ELEVATION



**WATER STORAGE TANKS, INC.**  
 1-800-463-1898  
 www.corgaltanks.com

	BY	DATE
DWN	IU	3/12/10
CKD	JH	3/12/10
ENG	JH	3/12/10

TITLE		MODEL 0604-WT-FS	
		COR GAL STEEL WATER STORAGE TANK	
		NOMINAL CAPACITY - 2,900 GALLONS (U.S.)	
DWG. NO.		0604-WT-FS	REV. NO.
			B

THE DRAWING DEPICTED ON THIS PRINT AND THE INFORMATION CONTAINED HEREIN ARE PROPRIETARY TO Water Storage Tanks, Inc. AND SHALL NOT BE USED IN WHOLE OR PART WITHOUT THE WRITTEN CONSENT OF Water Storage Tanks, Inc.

SIZE	SCALE	SHEET	OF
A	1/4"=1'-0"	1	1